

TEHNIČKI GLASNIK

TEHNIČKI GLASNIK / TECHNICAL JOURNAL – GODIŠTE / VOLUME 11 – BROJ / NUMBER 4

PROSINAC 2017 / DECEMBER 2017 – STRANICA / PAGES 143-229



SVEUČILIŠTE SJEVER / UNIVERSITY NORTH – CROATIA – EUROPE

ISSN 1846-6168 (PRINT) / ISSN 1848-5588 (ONLINE)

TECHNICAL JOURNAL

TEHNIČKI GLASNIK - TECHNICAL JOURNAL

Scientific-professional journal of University North

Volume 11

Number 4

Varaždin, October-December 2017

Pages 143–229

Editorial Office:

Sveučilište Sjever – Tehnički glasnik
Sveučilišni centar Varaždin
104. brigade 3, 42000 Varaždin, Hrvatska
Tel. ++385/ 42/ 493 328, Fax. ++385/ 42/ 493 333
E-mail: tehnickiglasnik@unin.hr
http://tehnickiglasnik.unin.hr
http://www.unin.hr/djelatnost/izdavastvo/tehnicki-glasnik/
http://hrcak.srce.hr/tehnickiglasnik

Founder and Publisher:

Sveučilište Sjever / University North

Council of Journal:

Marin MILKOVIĆ, Chairman; Goran KOZINA, Member; Vladimir ŠIMOVIĆ, Member; Mario TOMIŠA, Member;
Vlado TROPŠA, Member; Damir VUSIĆ, Member; Milan KLJAJIN, Member; Anatolii KOVROV, Member

Editorial Board:

Chairman Damir VUSIĆ (Sveučilište Sjever); Milan KLJAJIN (SF Slavonski Brod / Sveučilište Sjever);
Marin MILKOVIĆ, Krešimir BUNTAK, Anica HUNJET, Živko KONDIĆ, Goran KOZINA, Ljudevit KRAPAN, Marko STOJIĆ,
Božo SOLDI, Mario TOMIŠA, Vlado TROPŠA, Vinko VIŠNJIĆ (Sveučilište Sjever); Duško PAVLETIĆ, Branimir PAVKOVIĆ (TF Rijeka);
Mile MATIJEVIĆ, Damir MODRIĆ, Nikola MRVAC, Klaudio PAP i Ivana ŽILJAK STANIMIROVIĆ (GF Zagreb);
Krešimir GRILEC, Biserka RUNJE, Predrag ČOSIĆ (FSB Zagreb); Dražan KOZAK, Roberto LUJIĆ, Leon MAGLIĆ, Ivan SAMARDŽIĆ,
Ante STOJIĆ, Katica ŠIMUNOVIĆ, Goran ŠIMUNOVIĆ (SF Slavonski Brod); Ladislav LAZIĆ (MF Sisak); Ante ČIKIĆ (VTŠ Bjelovar);
Darko DUKIĆ (Sveučilište u Osijeku, Odjel za fiziku); Gordana DUKIĆ (Filozofski fakultet u Osijeku); Srđan MEDIĆ (VELK Karlovac);
Sanja KALAMBURA (Veleučilište Velika Gorica); Marko DUNĐER (FF Rijeka, Odsjek za politehniku);
Zlata DOLAČEK-ALDUK, Dina STOBER (GF Osijek)

International Editorial Council:

Boris TOVORNIK (UM FERi Maribor); Milan KUHTA (University of Maribor, Faculty of Civil Engineering);
Nenad INJAC (KPH Wien/Krems); Džafer KUDUMOVIĆ (MF Tuzla); Marin PETROVIĆ (MF Sarajevo); Salim IBRAHIMEFENDIĆ (KF Kiseljak);
Zoran LOVREKOVIĆ (VTŠ Novi Sad); Igor BUDAK (Fakultet tehničkih nauka, Univerzitet u Novom Sadu); Darko BAJIĆ (Mašinski fakultet Univerziteta Crne Gore);
Tomáš HANÁK (Brno University of Technology, Czech Republic); Nikolaj SURIANINOV, Evgenij KLIMENKO, Oleg POPOV
(Odessa State Academy of Civil Engineering and Architecture, Ukraine)

Editor-in-Chief:

Milan KLJAJIN

Technical Editor:

Goran KOZINA

Graphics Editor:

Snježana IVANČIĆ VALENKO

Linguistic Advisers for English language:

Ivana GRABAR, Iva GRUBJEŠIĆ

IT support:

Davor LEVANIĆ

Print:

Centar za digitalno nakladništvo, Sveučilište Sjever

All manuscripts published in journal have been reviewed.**Manuscripts are not returned.****The journal is free of charge and four issues per year are published.****Circulation: 100 copies****Journal is indexed and abstracted in:**

Web of Science Core Collection (Emerging Sources Citation Index - ESCI), EBSCOhost Academic Search Complete, EBSCOhost – One Belt, One Road Reference Source Product,
ERIH PLUS, CITEFACTOR – Academic Scientific Journals, Hrčak - Portal znanstvenih časopisa RH

Registration of journal:

The journal "Tehnički glasnik" is listed in the HGK Register on the issuance and distribution of printed editions on the 18th October 2007 under number 825.

Preparation ended:

December 2017

CONTENT	I
NOTE FROM THE EDITOR-IN-CHIEF	II
<i>Duspara M., Starčević V., Samardžić I., Horvat M.</i> OPTIMIZATION OF ABRASIVE WATERJET MACHINING PROCESS PARAMETERS	143
<i>Kos Ž., Gotal Dmitrović L., Klimenko E.</i> DEVELOPING A MODEL OF A STRAIN (DEFORMATION) OF A DAMAGED REINFORCED CONCRETE PILLAR IN RELATION TO A LINEAR LOAD CAPACITY	150
<i>Veliki T.</i> FREEZING POINTS OF PURE METALS AS DEFINING POINTS OF INTERNATIONAL TEMPERATURE SCALE ITS-90	155
<i>Lutskiy Y., Shynkevych O., Aniskin A.</i> MULTIPLE INFLUENCE OF SILICA-CONTAINING COMPONENT OF THE CHEMO-BIOGENIC ORIGIN ON THE STRUCTURE AND PROPERTIES OF COMPOSITES ON SILICATE MATRIX	160
<i>Šolić S., Schauperl Z., Godec M., Tropša V.</i> MICROSTRUCTURAL CHANGES IN HEAT TREATMENT OF PM HIGH-SPEED STEELS	166
<i>Svilović S., Horvat I., Čosić M., Stipišić R.</i> INVESTIGATION ON THE EFFECTS OF PROCESS VARIABLES ON COPPER EXCHANGE ON NaX IN A BATCH STIRRED REACTOR	171
<i>Kovrov A., Kovtunen A., Vysochan N.</i> STRAIN DIAGRAMS OF CROSS-SECTION OF REINFORCED CONCRETE BENDING ELEMENTS	175
<i>Can E., Sayan H. H.</i> THE PERFORMANCE OF THE DC MOTOR BY THE PID CONTROLLING PWM DC-DC BOOST CONVERTER	182
<i>Liu C.</i> NUMERICAL INVESTIGATION OF THE INFLUENCE OF TIP CLEARANCE AND ROTOR-STATOR INTERACTION ON CENTRIFUGAL PUMP PERFORMANCE AND CAVITATION	188
<i>Lešić A., Majnarić I., Modrić D., Morić M., Bolanča Mirković I.</i> LIGHT PERMANENCE WRAP PRINTS PRODUCED WITH CMYK UV INKJET INKS	195
<i>Menelyuk A., Petrovskiy A., Borisov A., Nikiforov A.</i> SEEPAGE PROTECTION OF IRRIGATION CANALS USING HORIZONTAL DIRECTIONAL DRILLING	201
<i>Dmitrieva N., Popov O., Hostryk A.</i> THE INFLUENCE OF CONSTRUCTION AND PROCESS DESIGN ON IMBIBITIONAL PROPERTIES OF "WATERPROOFING – LIMESTONE SHELL" SYSTEM	210
<i>Hermanová L., Hanák T.</i> AN EMPIRICAL ANALYSIS OF OVERHEAD COST MANAGEMENT IN THE CZECH CONSTRUCTION INDUSTRY	216
<i>Gajski I., Topolšek D., Cvahte Ojsteršek T., Sternad M.</i> IMPLEMENTING TRANSPORT STRATEGIES BASED ON SUSTAINABLE MOBILITY IN THE COUNTY OF VARAŽDIN	221
Instructions for authors	III

SEEPAGE PROTECTION OF IRRIGATION CANALS USING HORIZONTAL DIRECTIONAL DRILLING

Aleksandr MENEYLYUK, Anatoliy PETROVSKIY, Aleksandr BORISOV, Aleksey NIKIFOROV

Abstract: The paper is dedicated to the development of methods of waterproofing curtains arrangement for seepage protection of irrigation canals. The analysis of the informational sources in the field of seepage protection of irrigation canals has been conducted together with the use of horizontal directional drilling and the bentonite usage. The innovative technology of such works is proposed. The gist of the innovative technology is the combination of horizontal directional drilling and waterproofing bentonite-containing mortar injection. The laboratory experiments of the protective curtain arrangement are conducted. Bentonite powder concentration per unit of volume of hardening mortar, discharge pressure (supply) of injection mortar, and duration of mortar supply are chosen as the most influencing technological factors. Soil filtration coefficient is selected as the most important indicator. It is concluded that the combination of values of low bentonite powder concentration and relatively high discharge pressure allows obtaining lowest soil filtration coefficient values.

Keywords: bentonite; horizontal directional drilling; irrigation canals seepage; soil filtration coefficient; waterproofing curtain

1 INTRODUCTION

Analysis of the problems arising from the underground loss of water in the irrigation canals of the southern regions showed that the scale of the impact and the need for financial and technical resources are playing a dominant role in conservation of water resources intended for the reclamation of arid regions. The arrangement of waterproofing curtains can be used to protect irrigation water from losses during transportation through extended channels. Numerous methods help to build such curtains, but their analyses showed low economic and environmental performance. According to this, the elaboration of innovative seepage protection technology is relevant. The present study has a social significance, as it will allow to provide the population with timely supply of water intended for reclamation.

2 THE AIM AND TASKS OF THE STUDY

The aim of the study is to determine the optimum operating parameters of the waterproofing curtain arrangement for irrigation canals seepage protection by processing and analyzing experimental statistical dependency of soil filtration coefficient from the studied factors. In keeping with this purpose, the following research objectives were formulated:

- Analyze the informational sources in the areas of protection from irrigation water loss, usage of horizontal directional drilling, binders for anti-filtration injection mortar.
- Work out the conception of innovative technology.
- Develop the methodology for laboratory research of anti-filtration underground shields and construct the appropriate laboratory bench.
- Carry out the laboratory research of arrangement of waterproofing curtain by horizontal directional drilling

with varying technological parameters of mortar injection.

- Build and analyze the experimental statistical dependencies of curtain filtration coefficient from technological factors by regression analysis of laboratory results with the help of "Compex" software.
- Determine the technological parameters of waterproofing curtain arrangement in which an optimal value of soil filtration coefficient is obtained.

3 ANALYSIS OF INFORMATION SOURCES

Different research shows that methods of water management in different countries can be significantly improved. The developed water management scenarios [1] showed that water, which could be used in the agricultural land expansion, can be saved by 43÷52 % (4.7÷5.7 billion m³). The findings indicate that average technical, allocative, and overall economic efficiency of irrigation water use in the Northern China are 0.35, 0.86 and 0.80, respectively [2]. According to [3], the loss of water by the seepage from unlined canals in India generally varies from 0.3 to 7.0 m³/s per 100 m² of wetted surface.

Ukraine is also suffering from non-effective water management techniques. There are lengthy irrigation canals in Ukraine (Tab. 1). According to studied sources [4], there are problems with underflooding of agricultural territories due to seepages of irrigation canals. This proves that the problem of reduction of irrigation canals in Ukraine, as well as in the whole world, is an urgent problem.

Scientists of Iran have suggested that the installation of a grout curtain in hydraulic projects can be rational, based on the reviewing many types of waterproofing methods regarding cost, feasibility and safety factors [5]. Measurements showed that irrigation water loss rates, while influenced by soil texture, were even more strongly influenced by the condition and composition of channel

banks [6]. It is concluded [3] that the seepage loss from canals is governed by hydraulic conductivity of the subsoil, canal geometry, and water depth relative to the canal bed. According to that, the method of reducing the water seepage by injection of surrounding soil with bentonite-containing mortar can be effective from the technical point.

Fundamental research suggests several methods for the reduction of seepage losses of irrigation canals. One of them is lining of canal banks [7]. The annual groundwater

recharge in the irrigated areas can be reduced by approximately 50 % by concrete lining of irrigation canals banks [8]. Still, researches confirm, that large losses from canals have been identified, even when the canal is lined [9]. It is shown [10] that the seepage flow can go both through canals with impervious lining on their sloping sides and canals in which the impervious lining is located on the bottom of the canal and the sides are unlined. Moreover, lining is an extremely expensive procedure.

Table 1 Irrigation canals of Ukraine [11]

Canals and waterways of Ukraine	Years of erection	Length, km	Height difference of the canal end points, m
Dnepr-Donbas Canal (the 1 st stage of construction)	1970-1982	263	68.3
Dnepr-Donbas Canal (the 2 nd stage of construction)	1980-1997 (unfinished)	171	68.3
Dnepr-Ingulets Canal	1978-1988	150.5	55.5
Dnepr-Krivoy Rog Canal	1957-1961	41.3	83.8
Inguletsky Canal	1951-1963	53.5	57
Kakhovsky Canal	1980	130	24
North Crimean Canal	1957	400.4	100
Seversky Donets-Donbass Canal (the 1 st stage of construction)	1928-1930	131.6	200
Seversky Donets-Donbass Canal (the 2 nd stage of construction)	1949-1954	123.3	200

The results of the research, conducted by the Iranian and British scientists, showed that the random reinforcement of soils with fiber can be an effective technique in controlling the seepage velocity and seepage force [12].

The two most known methods for determining losses from irrigation canals (inflow-outflow and ponding test) are quite expensive and time-consuming [13]. Several relatively inexpensive methods can be used for search and location of seepage places of irrigation canals, for example electromagnetic induction system [13], acoustic Doppler current profilers [14, 15].

Thus, it can be suggested, that it is very useful and economically effective to locate the place of the loss and liquidate it. For this, the combination of horizontal directional drilling and injection with waterproofing mortar can be used.

As a result of the analysis of Ukrainian sources on the subject, it can be concluded that the existing methods of the waterproofing curtain arrangement are not effective for the localization of irrigation water loss [16, 17, 18, 19, 20]. In recent years, several attempts were made to develop an efficient technology for similar works [21], but the use of horizontal directional drilling (HDD) technology for groundwater protection shields can be more promising from an economic or technological perspective.

Horizontal directional drilling technology is described in many sources, for example, in [22]. It can be used for laying and rehabilitation of underground communications, wells setting with different configurations in the soil column. The arrangement of such wells will allow to use them as a way of supplying an injectable solution into the desired region of underground space. Such an injection at the appropriate technological modes will make it possible to form waterproofing curtain at the place of water seepage.

The operation, which increases the complexity of work on HDD, is the installation of equipment in a specially

constructed pit [23]. Placement of the drilling rig on the earth surface can reduce labor costs and cash cost per arrangement of horizontal directional wells.

During the arrangement of curved shape wells, it is important to ensure the stability and accuracy of the drilling head move in the soil column. To that end, you can use special nozzles, technological modes of drilling [24].

The aforementioned confirms the possibility of the waterproofing curtain arrangement under the irrigation canals by drilling directional wells, pulling the injector into them followed by injecting of a hardening solution.

For effective shielding device it is important to choose a binder having hydrophobic properties. Bentonite can be considered as an effective tool for the waterproofing curtain arrangement [25]. Its use is possible mixed with larger fraction material [26, 27]. Glue properties of bentonite can be used for curtain arrangement, preventing the spread of radioactive substances [28]. Moreover, bentonite due to its low dispersion may be used as binder in the injectable solutions [29, 30].

4 THE CONCEPTION OF INNOVATIVE TECHNOLOGY

Innovative technology will provide a method for underground curtain arrangements under structures. Using this method will not only reduce the complexity and cost of projects, but will also shorten the time of production.

The problem is solved by the method of the construction of a waterproofing curtain. The horizontal, sloping or curved injection wells are created starting from the surface of the earth. The wells are pumped by injected mortar. After setting, this mortar forms a shield.

The scheme of works on the underground curtain arrangement is shown in the figures: Fig. 1 shows a vertical section through the axis of the pilot well when it is created; Fig. 2 - the same, when the injector is drawn into it; Fig. 3 -

the same, when the mortar is injected; Fig. 4 - cross-section of a curtain A-A.

The multi-step drilling process is outlined in Fig. 1 as follows. A number of parallel wells (6) are drilled in the ground (5) under irrigation canal (1) from the ground surface (2) curvilinear to the base of the canal (4). The injector (7) is pulled after completion of drilling the well (6) (Fig. 2). Then, the dilator (10) and the head with a hinge driving force (swivel) (11) are attached to the drill rod (9) instead of the drill bit (8), the swivel (11) is attached to the injector (7). Drilling rig (3) draws the injector (7) in the well (6) according to project trajectory, wherein the swivel (11) rotates with the drill rod (9) not transmitting rotational movement to the injector (7). Injection mortar is fed from the supply line (12) to the injector (7), which is drawn in by the traction device (13) (Fig. 3).

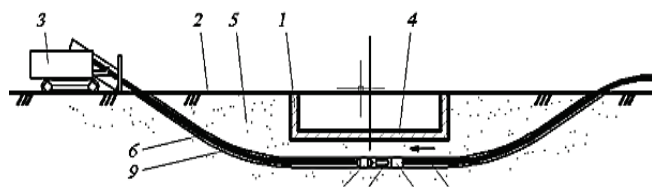

Figure 1 The pilot well drilling

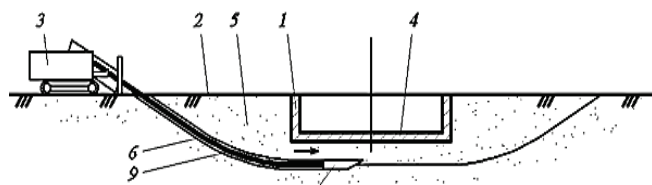

Figure 2 Drawing the injector in the well

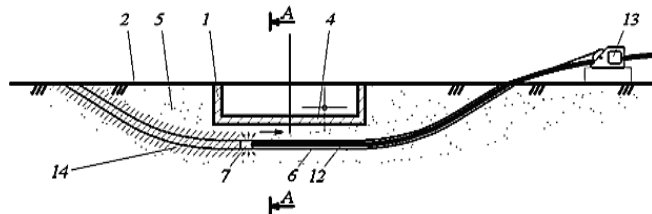

Figure 3 Injection of hardening mortar into the well

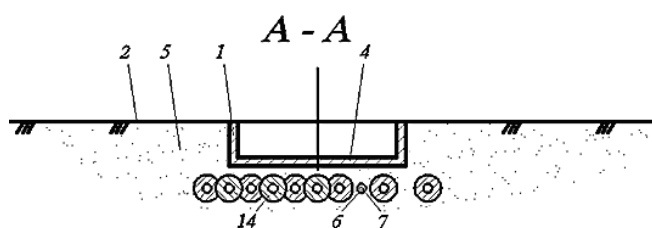

Figure 4 Cross-section A-A of the underground shield

The distance between the wells is assigned depending on the radius of mortar distribution and should not exceed two radii of distribution zone (Fig. 4). Soil injection is produced by hardening compounds, which are selected according to the permeability of rocks based on viscosity and time of mortar setting. After hardening of the mortar the

waterproofing curtain (14) is formed in the ground. The curtain is bent over the underground part of the building.

5 OVERALL METHODOLOGY OF THE STUDY

To simulate the injection process described above, the laboratory bench (Fig. 5) has been created. It simulates the section perpendicular to the axis of the well, wherein the injectable solution is distributed at various places away from the injection source.

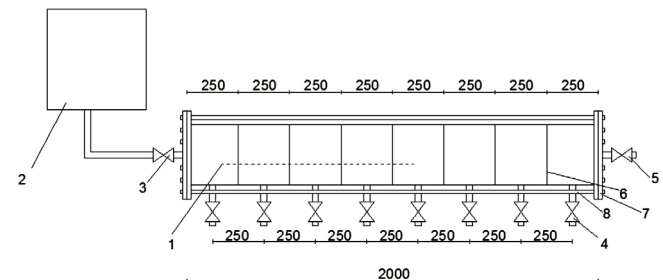

Figure 5 Scheme of laboratory test bench for injections: 1 - the cylindrical tank of the laboratory bench; 2 - the pump with pressure gauge for supplying the solution to the tank; 3 - crane for solution supplying; 4 - taps to indicate the filling tube with solution; 5 - tap for output of the solution; 6 - threaded joint sections; 7 - flanged end cap; 8 - metal ties to seal threaded connections.

Since the main feature of impervious screen is its impermeability to water, it was decided to select a soil filtration coefficient as a key indicator. This indicator represents the filtration rate when the pressure gradient is equal to unity, and is measured in 'm/day' or 'cm/sec'. Determination of filtration coefficient was carried out using the SPETSGEO device [31]. According to the normative documents [32], minimum allowances of filtration coefficient values were established in which the reliability of impervious properties can be considered as sufficient (Tab. 2). It is assumed that the curtain has reliable impervious properties when the value of filtration coefficient is less or equal to 0.3 m/day.

Three factors were chosen as having the greatest impact on the key indicator: X_1 , X_2 , and X_3 .

- X_1 - bentonite powder concentration per unit of volume of hardening mortar, which changes a soil filtration property. This factor is important because the bentonite-containing mortar prevents the penetration of water through injected ground. Considering this, the concentration of the bentonite should be sufficient to form the shield, which has a maximum capacity of impermeability. However, there is a limiting factor - viscosity of the injection mortar, which affects the penetration of material into the gaps between the fine particles of a sandy ground. According to sources considered [33, 34], the permissible viscosity for clay and cement mortars is between 26 and 43 sec. The viscosity was determined by viscometer "Marsh Funnel" with volume of 1000 ml.
- X_2 - discharge pressure (supply) of injection mortar in the base soil. Discharge pressure affects the range of injection mortar spread in soil. This factor is very

important in economic terms, as modern industrial pumps can achieve more than 100 bar pressures, at the same time allowing you to increase the distance between the horizontally drilled wells, which can reduce the cost of the project.

- X_3 - the duration of mortar supply, by which a curtain is formed. Time factor could allow establishing a direct proportional relationship between the injection time and the concentration of active substances which affects the properties of impervious soil shield.

6 METHODOLOGY OF LABORATORY BENCH INJECTION

Test process included the following steps:

- 1) Preparing the lab bench to the tests.
- 2) Filling a cylindrical tank of the test bench by sand and preparing for the injection.
- 3) The injection process with the specified parameters.
- 4) Technological break.
- 5) Definitions of the filtration coefficient, fixing the results.

Preparation of the laboratory bench for testing included lubrication of threaded joints, tank installation in vertical position to be filled with sand, as well as preparation of materials, tools and instruments used in the test. Characteristics of sand used to fill the bench are shown in Tab. 3.

Table 3 Physical properties of sand to be injected during laboratory experiments

#	Name of the characteristic	Value of indicator	
1	Grain composition: total balances on sieve, %		
	2.5 mm	14.5 %	14.5 %
	1.25 mm	25.0 %	39.5 %
	0.63 mm	20.0 %	59.5 %
	0.315 mm	31.25 %	90.75 %
	0.14 mm	8.25 %	9.0 %
	has passed through a sieve of 0.14 mm	0.1 %	-
2	The content of grains measuring more than 10.0 mm, must not exceed % by weight	0.5	
3	The content of grains larger than 5.0 mm should not exceed % by weight	5.5	
4	Gradation factor	2.0	
5	Pulverized, clay particles, %	1.0	
6	Bulk density, kg/m ³	1420	
7	Humidity, %	2	
8	Clay in lumps	no	

Table 4 Physical properties of bentonite

#	Name of the property	Unit of measurement	Value
1	The content of montmorillonite (XRD analysis)	%	>80
2	Swelling Index (ASTM D 5890)	ml/gr ²	> 24
3	Water loss (ASTM D 5891)	ml	> 18

During injection, the mortar was periodically stirred in order not to change the solution concentration.

Injection of mortar was happening with the defined technological parameters: a certain pressure and a predetermined time. Crane located opposite the point of the mortar injection remained open throughout the experiment until the moment when the mortar passed through the laboratory bench and did not start to flow through it.

Filling of the cylindrical tank of the laboratory bench was carried out in an upright position with layer-wise sand compaction. Sealing was carried out by ramming. Thus, the achieved density was close to the density of sandy soil under natural conditions. After filling the pipe tank was brought to the horizontal position.

Table 2 The division of soils according to the permeability degree

Soil type	Soil filtration coefficient (meter/day)
waterproof	< 0.005
nearly waterproof	0.005...0.30
moderately waterproof	0.30...3
weakly waterproof	3...30
non-waterproof	>30

The following requirements were identified while formulating research problems of selection of injectable solution components:

- components should have waterproof properties or capable of forming a stable waterproof structure;
- environmental safety components of the composition;
- convenience throughout the work (good miscibility, convenience when measured proportions, and so on).

Characteristics of bentonite, used in injection mortar, are shown in Tab. 4.

Preparation of the mortar took place in a separate container immediately prior to injection. Measured amounts of the components were poured into the tank and were stirred by means of a mixer into a homogeneous mortar.

7 METHODS OF DETERMINATION OF SOIL FILTRATION COEFFICIENT BY THE SPETS GEO DEVICE

The sequence of determination of soil filtration coefficient:

- 1) Fill the tube 1 (Fig. 6) with the tested sandy soil.
- 2) Fill the tube with the sand producing layers.
- 3) Fill the measuring cylinder with water, turn it over the tube and set the top cover so that its neck would be placed above the ground surface on approximately 0.5÷1 mm.

As such, the measuring cylinder maintains a constant water level above the sample. As a result of the infiltration of water through the sample, the level goes down, the air bubble breaks in a graduated cylinder and the corresponding amount of water is put out of it. By this the water gradient is achieved, its numerical value is equal to one and the pressure is equal to the length of filtration path.

If after installation large air bubbles break into the cylinder, it indicates that the neck of the cylinder is located too far from the ground surface. In this case, the measuring cylinder has to be pushed a little deeper in order to let only small air bubbles to rise through the water, following one after the other at the same distance.

- 1) After reaching the specified mode, measure the scale of water level in the cylinder (1), start the stopwatch and fix the second level after a certain time (50÷100 seconds for medium-grained sand, 250÷500 seconds for clay sand).
- 2) Repeat the test several times, record observations, and calculate the average value of the soil filtration coefficient for them. Determination of soil filtration coefficient was carried out according to the formula of [31],

$$k = \frac{Q}{T \times F}, \quad \text{cm/s} \quad (1)$$

where: Q - volume of water filtered during the time T , cm^3 ;
 T - filtration time, s; F - area of the tube section, cm^2 .

SPETSGEO device for determination of the soil filtration coefficient is shown on Fig. 6.

8 METHODOLOGY OF STATISTICAL ANALYSIS OF EXPERIMENTAL DATA

As part of the experimental laboratory research it is most convenient to follow a special plan, or a planning matrix, defined as:

$$N = 2^n, \quad (2)$$

where: N - number of experiments, sufficient to describe the response functions within the studied factor space; n - number of variable factors that determine the process.

In the calculations of this research assessment of the impact factors, it has been decided to obtain the response function of the second degree, where: Y - a function of hail; B_i - regression coefficients; X_i - variable factors.

Table 5 Matrix of varying researched factors

#	Factor's indication	-1	0	+1
1	X_1	10 gr/l	40 gr/l	70 gr/l
2	X_2	2.027 bar	3.040 bar	5.066 bar
3	X_3	10 min	60 min	110 min

For reliable results, it has been decided to take a 15-point symmetrical plan "B3" with repetition of experiments at each point not less than 3 times. Matrix of varying the

technological parameters of injection (investigated factors) is shown in Tab. 5. The coding of factors value was made as follows: the medium value of each factor was marked as "0", the minimal as "-1" and the maximal - as "+1".

Despite the fact that for a complete experiment with three factors, which vary on 3 levels, it is required to conduct 27 tests, the optimal experimental planning allows to take only 15 tests. This will still keep the same research accuracy.

Calculation of experimental statistical model was performed taking into account the adopted experimental error. Two-way risk was set at a typical level of 10 % ($\alpha = 0.1$). After that the testing was conducted to determine the difference of calculated coefficient estimates from zero. The Gauss's criterion was used for this calculation. Coefficient estimates, which were acknowledged as indistinguishable from zero, were consistently excluded from the experimental statistical model. After this model with all significant coefficient estimates was tested for adequacy by the Fisher test. If this criterion was not critical for a given risk value, the model was assumed to be correct for engineering solutions and analysis. Calculation of the coefficients and statistical analysis of experimental statistical model was performed using the dialogue system COMPEX-99, which was developed in the Odessa State Academy of Civil Engineering and Architecture [35].

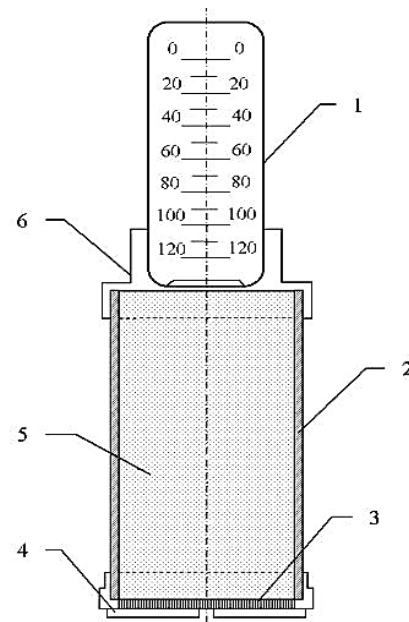

Figure 6 SPETSGEO device for determination of soil filtration coefficient: 1 - the glass measuring cylinder with a scale division 1 cm^3 ; 2 - the major tube; 3 - bedplate, which is attached on the lower part of the cylinder; 4 - the bottom cover; 5 - the cavity that is filled with soil; 6 - the top cover.

9 METHOD OF SELECTION OF THE INJECTABLE MORTAR COMPOSITION

Selection of an injectable mortar composition determined the most suitable concentration of the solution components. Preparation of the sample solution and determination of the viscosity was conducted in accordance

with the study plan and predetermined binder concentration. When mixing the solution, the sequence of components addition was respected. Mixing occurred as long as the sediment at the bottom of the tank did not disappear.

$$Y_j = B_0 + B_1X_1 + B_{11}X_1^2 + B_{12}X_1X_2 + B_{13}X_1X_3 + B_2X_2 + B_{22}X_2^2 + B_{23}X_2X_3 + B_3X_3 + B_{33}X_3^2. \quad (3)$$

Determination of the mortar viscosity was performed using Marsh funnel viscometer according to the procedure [36] (see Fig. 7).

The algorithm of composition selection is a sequence of the following actions:

- 1) Prepare the sample of the solution.
- 2) Hold funnel vertically plugging the outlet with a finger, pour the solution into the funnel through a sieve (sieve filters out large particles, which may stall the outlet funnel).
- 3) Quickly remove finger from the outlet, and immediately start the countdown.

- 4) Enable solution to emerge from the Marsh funnel into a graduated container.
- 5) Record the time in seconds that it took for the solution to leave the funnel.



Figure 7 Viscometer "Marsh Funnel"

Table 6 The plan and the results of experimental laboratory studies

№	Actual value of factors			Coded value of factors			Soil filtration coefficient (SFC), meter per day
	X ₁	X ₂	X ₃	X ₁	X ₂	X ₃	
	Bentonite powder concentration, grams per liter	Discharge pressure of mortar, bar	Duration of mortar supply, min	Bentonite powder concentration	Discharge pressure of mortar	Duration of mortar supply	
1	2	3.040	4	5	6	7	8
1	70	5.066	110	1	1	1	0.37114
2	70	5.066	10	1	1	-1	0.26929
3	70	2.027	110	1	-1	1	0.21114
4	10	5.066	110	-1	1	1	0.07526
5	70	2.027	10	1	-1	-1	0.40124
6	10	5.066	10	-1	1	-1	0.08985
7	10	2.027	110	-1	-1	1	0.80065
8	10	2.027	10	-1	-1	-1	0.36041
9	70	3.040	60	1	-0.33	0	0.34387
10	10	3.040	60	-1	-0.33	0	0.29899
11	40	5.066	60	0	1	0	0.15554
12	40	2.027	60	0	-1	0	0.08977
13	40	3.040	110	0	-0.33	1	0.14669
14	40	3.040	10	0	-0.33	-1	0.17049
15	40	3.040	60	0	-0.33	0	0.04775

10 THE RESULTS OF EXPERIMENTAL STUDIES

Tab. 6 presents the experimental data. The columns 2 and 5, 3 and 6, 4 and 7 show actual and coded values of studied value respectively. The value of soil filtration coefficient, shown in the table, can be obtained at the distance of 2 meters or less from the source of the mortar. The dependency of soil filtration coefficient on technological factors (bentonite powder concentration, discharge pressure and duration of mortar supply) is shown in the equation 1. Points in this formula mark the factor impact estimations, deemed indistinguishable from zero.

Fig. 8 shows the ranking of the degree of variable factors influence on the indicator.

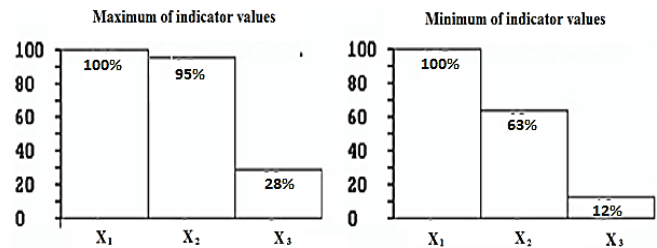

Figure 8 Ranking the impact of variable factors on the indicator (soil filtration coefficient)

The greatest influence on the filtration coefficient in the area of maximum indicator values has two factors in approximately the same degree: the concentration of

bentonite powder and discharge pressure of mortar. At the same time, the duration of mortar supply does not play such a significant role in the change of the indicator. In the area of minimum indicator values, where the dependencies are the most significant from the perspective of results implementation, the degree of influence of the discharge pressure decreased slightly. The degree of the time factor influence in the considered factor space has decreased to the limits that are not significant from an engineering point of view.

$$SFC \text{ (m/day)} = 0.105 \bullet + 0.212X_{12} + 0.123X_1X_2 - 0.064X_1X_3 - 0.087X_2 + \bullet + \bullet + \bullet + \bullet \quad (4)$$

These rankings can be interpreted as follows:

- Bentonite concentration in the mortar plays the most important role for the following reasons: the conditions of the experiments carried out have enabled the most complete way to explore this relationship in the selected factor space, which is confirmed by the nature of the graph shown in Fig. 9; composition of the mortar does play a major role in the arrangement of protective shields.
- From a physical point of view, the degree of influence of pressure on impervious properties is quite high, as the supply pressure of the mortar directly affects the amount of bentonite injected into the soil.
- Duration of mortar supply factor is not significant from an engineering point of view on the change of the monitoring indicator within the selected experimental conditions.

Fig. 9 shows graphs of the indicator from each of variable factors.

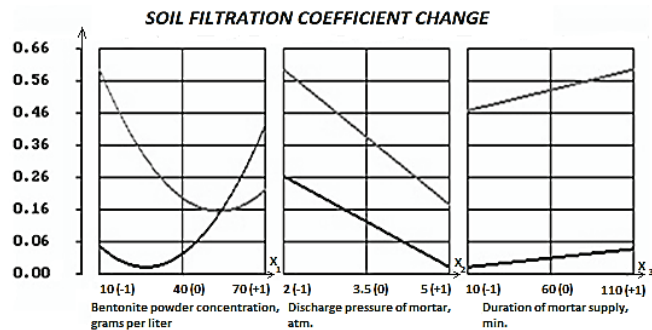

Figure 9 Indicator of dependence on the factors (dark lines and curves show dependence on each of the studied factors in the area of minimum indicator value, light lines – in the area of maximum value).

The nature of the graph of the soil filtration coefficient from bentonite concentration can be interpreted as similar to parabolic. In this case, the extreme point of this curve is vividly shown and is within $X_1 = (-0.4, -0.5)$ in the minimum indicator area, whereas it is within $X_1 = (0.6, 0.7)$ in the maximum zone. It can be said that for the conditions studied in the experiments, it was possible to identify the optimal conditions for bentonite powder concentration. When translating into full-scale parameters, the most

effective mortar in the minima zone would contain the amount of bentonite within 22÷25 grams per liter, in the area of the maxima – 58÷61 g/l.

The dependence of soil filtration coefficient from the discharge pressure of mortar is inversely proportional. The angle of the line to the horizontal is sufficiently sharp, therefore we can assume that the data points belong to the parabolic nature of the curve with a peak, not included in considered factor space. In this case, used pressure values are not the highest possible from a technical point of view and may be adjusted upward during the further study.

The effect of duration of mortar supply on the indicator value is directly proportional. Limits of soil filtration coefficient changes are quite small for time variation, so you can conclude that the dependency, which follows from the obtained data, is not enough meaningful from an engineering point of view. However, under natural conditions, long duration of injection will undoubtedly affect the soil filtration coefficient of the waterproofing curtain to the reduction. The reason for this discrepancy may be due to imperfect experimental conditions.

Nature of the dependence obtained in the zone of high and low values of indicator are close. It should be noted that dependences obtained in the zone of the low values of indicator must be taken as highly significant. This is due to the ultimate goal of the experiments which is to determine the conditions under which the soil filtration coefficient of the waterproofing curtain will meet the specified conditions for water-proof resistance.

Fig. 10 shows the descending ranking values of soil filtration coefficient obtained during laboratory tests. By this ranking, the conditions, which are the most suitable for low values of indicator, can be analyzed.

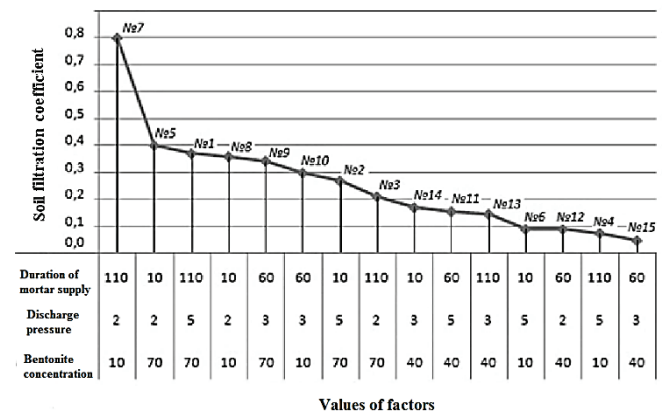

Figure 10 Graph of soil filtration coefficient values (ranked in descending order)

Five experiments were conducted, in which a mortar containing 40 grams of bentonite per liter was used. The majority of the experiments were carried out at the operating discharge pressure of $X_2 = 2.027\div 3.040$ bar. These experiments showed the lowest filtration value. Also, low values of filtration coefficient are determined in the experiments, in which the combination of low concentrations of bentonite (or the low viscosity of mortar) and relatively high discharge pressure were used. The

experiments, in which a high viscosity and low discharge pressure of mortar were used, showed slightly higher values of soil filtration coefficient. Finally, the least favorable were the combination of high contents of bentonite in mortar and high discharge pressure; small saturation of bentonite powder and a low pressure of mortar. Inconsistencies of experiments ranking can be attributed to the account of the corrective impact of duration of mortar supply.

Fig. 11 shows the effect of the bentonite powder concentration and discharge pressure on the filtration rate of the waterproofing curtain while the duration of mortar supply is fixed on the level $X_3 = 10$ min. This level was selected to avoid errors in the calculation of the dependency.

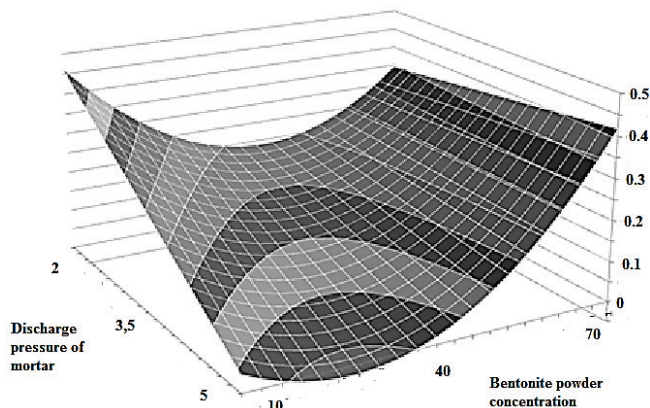

Figure 11 Change of the soil filtration coefficient of the waterproofing curtain under the influence of the bentonite powder concentration and discharge pressure when fixing the duration of mortar supply at $X_3 = 10$ min

Analysis of the graph shows that the dependence of the indicator on the concentration of bentonite is close to a parabolic arch. The effect of the discharge pressure of mortar supply is inversely proportional: minimum zone of soil filtration coefficient is formed at the highest pressures. Thus, in the case of short-term injection, the maximum pressure should be followed with the optimal concentration of bentonite in mortar at about 22÷25 grams per liter, with the least 43÷46 grams per liter, and less viscous mortar is more effective. The soil filtration coefficient is equal to 0.023 meters per day and 0.194 meters per day respectively to the parameters indicated. Thus it can be concluded that the value of discharge pressure effects the level of bentonite concentration in terms of lowest soil filtration coefficient values obtained.

11 CONCLUSIONS

1) The analysis of information sources showed high actuality of search for method of underground waterproofing curtain arrangement for irrigation canals seepage protection, low economic and technical efficiency of existing methods. Use of horizontal directional drilling and mortar, prepared with the use of bentonite, could be effective for such work.

- 2) The developed technique and research equipment allows determining the filtration coefficient of sand injected under different technology parameters.
- 3) The results of experimental studies allowed creating graphs and polynomial equations that define patterns of the impact of technological regimes and composition of an injectable solution on impervious properties of the shield.
- 4) Bentonite concentration in the injection mortar and the discharge pressure of mortar have the biggest impact on the index. Duration of mortar supply does not noticeably affect the indicator for the chosen experimental conditions.
- 5) The combination of values of low bentonite powder concentration (or the low viscosity of mortar) and relatively high discharge pressure allows to obtain lowest soil filtration coefficient values.
- 6) The optimum soil filtration coefficient value is equal to 0.023 meters per day, and is achieved at a bentonite powder concentration equal to 22-25 grams per liter and the discharge pressure of mortar – to 5.066 bar. It will allow building a reliable underground curtain with the distance between wells at 2 meters.

11 REFERENCES

- [1] H. Mostafa and N. Fujimoto, Water saving scenarios for effective irrigation management in Egyptian rice cultivation, *Ecological Engineering*, pp. 11-15, 2014.
- [2] J. Tang, H. Folmer and J. Xue, Technical and allocative efficiency of irrigation water use in the Guanzhong Plain, China, *Food Policy*, pp. 43-52, 2015.
- [3] Bureau of Indian Standards, Measurement of Seepage Losses from Canals, IS:9452 (Part I & II), 1980, New Delhi: (Bureau).
- [4] V. Kovalchuk, System management of irrigated areas water regime for protection against flooding, Kiev: Ukrainian Institute of Water Problems and Land Reclamation, 2016.
- [5] A. Uromeihy and G. Barzegari, Evaluation and treatment of seepage problems at Chapar-Abad Dam, Iran, *Engineering Geology*, pp. 219-228, 2007.
- [6] M. Kahlowan and W. Kemper, Seepage losses as affected by condition and composition of channel banks, *Agricultural Water Management*, pp. 145-153, 2004.
- [7] P. G. Nicholson, *Soil Improvement and Ground Modification Methods*, Hawaii: Butterworth-Heinemann, 2015.
- [8] K. Meijer, E. Boelee, D. Augustijn and I. van der Molen, Impacts of concrete lining of irrigation canals on availability of water for domestic use in southern Sri Lanka, *Agricultural Water Management*, pp. 243-251, 2006.
- [9] E. Wachyan and K. Rushton, Water losses from irrigation canals, *Journal of Hydrology*, pp. 275-288, 1987.
- [10] A. Mirnateghi and J. Bruch Jr., Seepage from canals having variable shape and partial lining, *Journal of Hydrology*, pp. 239-265, 1983.
- [11] Canals of Ukraine, 11 December 2016. Available: <http://www.photoukraine.com/russian/articles?id=26>.
- [12] A. Estabragh, A. Soltani and A. Javadi, Models for predicting the seepage velocity and seepage force in a fiber reinforced silty soil, *Computers and Geotechnics*, pp. 174-181, 2016.

- [13] D. Pognant, D. Canone and M. Previa, Using EM Equipment to Verify the Presence of Seepage Losses in Irrigation Canals, *Procedia Environmental Sciences*, pp. 836-845, 2013.
- [14] K.-D. Kinzli, M. Martinez, R. Oad, A. Prior and D. Gensler, Using an ADCP to determine canal seepage loss in an irrigation district, *Agricultural Water Management*, pp. 801-810, 2010.
- [15] C. A. Martin and T. K. Gates, Uncertainty of canal seepage losses estimated using flowing water balance with acoustic Doppler devices, *Journal of Hydrology*, pp. 746-761, 2014.
- [16] A. Adamovich, Grouting and grout curtain in the hydropower construction (Zakreplenie gruntov i protivofil'tracionnye zavesy v gidrojenergeticheskom stroitel'stve), Moscow: Jenergiya, 1980.
- [17] A. G. Alimov, Antifiltration protection of canals and reservoirs (Protivofil'tracionnaja zashhita kanalov i vodoemov), *Gidrotehnicheskoe stroitel'stvo*, pp. 36-42, 2008.
- [18] J. M. Ammosova, Soil protection against chemical pollution (Ohrana pochv ot himicheskikh zagraznenij), Moscow: MGU, 1989.
- [19] V. F. Val'kov, K. S. Kazeev and S. I. Kolesnikov, Soil Ecology: a textbook for university students (Jekologija pochv : uchebnoe posobie dlja studentov vuzov), Rostov-na-Donu: UPL RGU, 2004.
- [20] V. Zadgenidze, Protecting areas from flooding (Zashhita territorij ot podtoplenija. Praktikum: metod. posob.), Odessa: OGASA, 2005.
- [21] A. Chernuhin and A. Galinskij, Application of the method "a diaphragm underground wall" for the localization of radioactive waste disposal points (Primenenie sposoba "stena v grunte" dlja lokalizacii punktov zahoronenija radioaktivnyh othodov, *Stroitel'noe Proizvodstvo*, pp. 7-10, 1997.
- [22] E. Skonberg, C. E. Tammi, A. M. Desilets, V. Srivastava and J. M. Evans, *Horizontal Directional Drilling Best Management Practices Manual*, New York: GRI, 2002.
- [23] T. Zayed and M. Mahmoud, Data acquisition and factors impacting productivity of Horizontal Directional Drilling (HDD), *Tunnelling and Underground Space Technology*, pp. 63-72, 2013.
- [24] F. Hungerford and T. Ren, Directional drilling in unstable environments, *International Journal of Mining Science and Technology*, pp. 397-402, 2014.
- [25] C. Imbert and M. V. Villar, Hydro-mechanical response of a bentonite pellets/powder mixture upon infiltration, *Applied Clay Science*, pp. 197-209, 2006.
- [26] M. Villar, Infiltration tests on a granite/bentonite mixture: Influence of water salinity, *Applied Clay Science*, pp. 96-109, 2006.
- [27] L. Xu, W. Ye, B. Chen, Y. Chen and Y. Cui, Experimental investigations on thermo-hydro-mechanical properties of compacted GMZ01 bentonite-sand mixture using as buffer materials, *Engineering Geology*, pp. 46-54, 2016.
- [28] J. Vaunat and A. Gens, Analysis of the hydration of a bentonite seal in a deep radioactive waste repository, *Engineering Geology*, pp. 317-328, 2005.
- [29] M. Holmboe, S. Wold and T. Petterson, Effects of the injection grout Silica sol on bentonite, *Physics and Chemistry of the Earth*, pp. 1580-1589, 2011.
- [30] L. P. Chegbeleh, S. M. Yidana, M. Nishigaki and F. Achampong, Comparative study on the application of ethanol-bentonite slurry and salt-bentonite slurry as effective injection materials for barrier sealing, *Applied Clay Science*, pp. 40-45, 2014.
- [31] Soils. Laboratory methods for determining the filtration coefficient (State Standard of the USSR - Grunty. Metody laboratornogo opredelenija koeficienta fil'tracii - GOST 25584-90), 1990. Available: <http://www.gosthelp.ru/text/GOST2558490GruntyMetodyla.html>.
- [32] Soils. Classification (Grunti. Klasifikacija - State Standard of Ukraine - DSTU B V.2.1-2-96 (GOST 25100-95)), 1996. Available: <http://normativ.com.ua/types/tdoc353.php>.
- [33] A. Chapovskij, Laboratory work on soil science and soil mechanics (Laboratornye raboty po gruntovedeniju i mehanike gruntov), Moscow: Nedra, 1975.
- [34] A. Churakov, Production of special works in hydraulic engineering (Proizvodstvo special'nyh rabot v gidrotehnicheskome stroitel'stve), Moscow: Sroyzdat, 1976.
- [35] V. Voznesenskij, T. Ljashenko and B. Ogarkov, Numerical methods for solving construction and technological problems on a computer (Chislennye metody reshenija stroitel'no-tehnologicheskikh zadach na JeVM), Kiev: Vyshha shkola, 1989.
- [36] Soils. Laboratory tests. General provisions (State Standard of Ukraine - Grunty. Laboratorni viprobuvannja. Zagal'ni polozhennja - DSTU B V.2.1-3-96 (GOST 30416-96)), 1996. Available: http://online.budstandart.com/ua/catalog/doc-page?id_doc=4079.

Authors' contacts:**Aleksandr MENEYLYUK**

Doctor in technical sciences, Full professor, Head of Department of Technology of building industry, Odessa State Academy of Civil Engineering and Architecture, ORCID ID: 0000-0002-1007-309X,
E-mail: pr.mai@mail.ru

Anatolij PETROVSKIY

PhD (technical sciences), professor, doctoral student, Odessa State Academy of Civil Engineering and Architecture,
E-mail: san-one@te.net.ua

Aleksandr BORISOV

PhD (technical sciences), Associate Professor, Odessa State Academy of Civil Engineering and Architecture,
E-mail: komar9@mail.ru

Aleksey NIKIFOROV (corresponding author)

Master (technical sciences), postgraduate student, Odessa State Academy of Civil Engineering and Architecture, ORCID ID: 0000-0001-7002-7055, tel. (fax) +38(066)-33-09-054, Postal address: 2 (ap. 1), Kartamyshevsky Ln, Odessa, Ukraine, 65091
E-mail: aleksey-nikiforov@mail.ua